

Square Gift Box
Base - Finished size 100mm x 100mm x 65mm

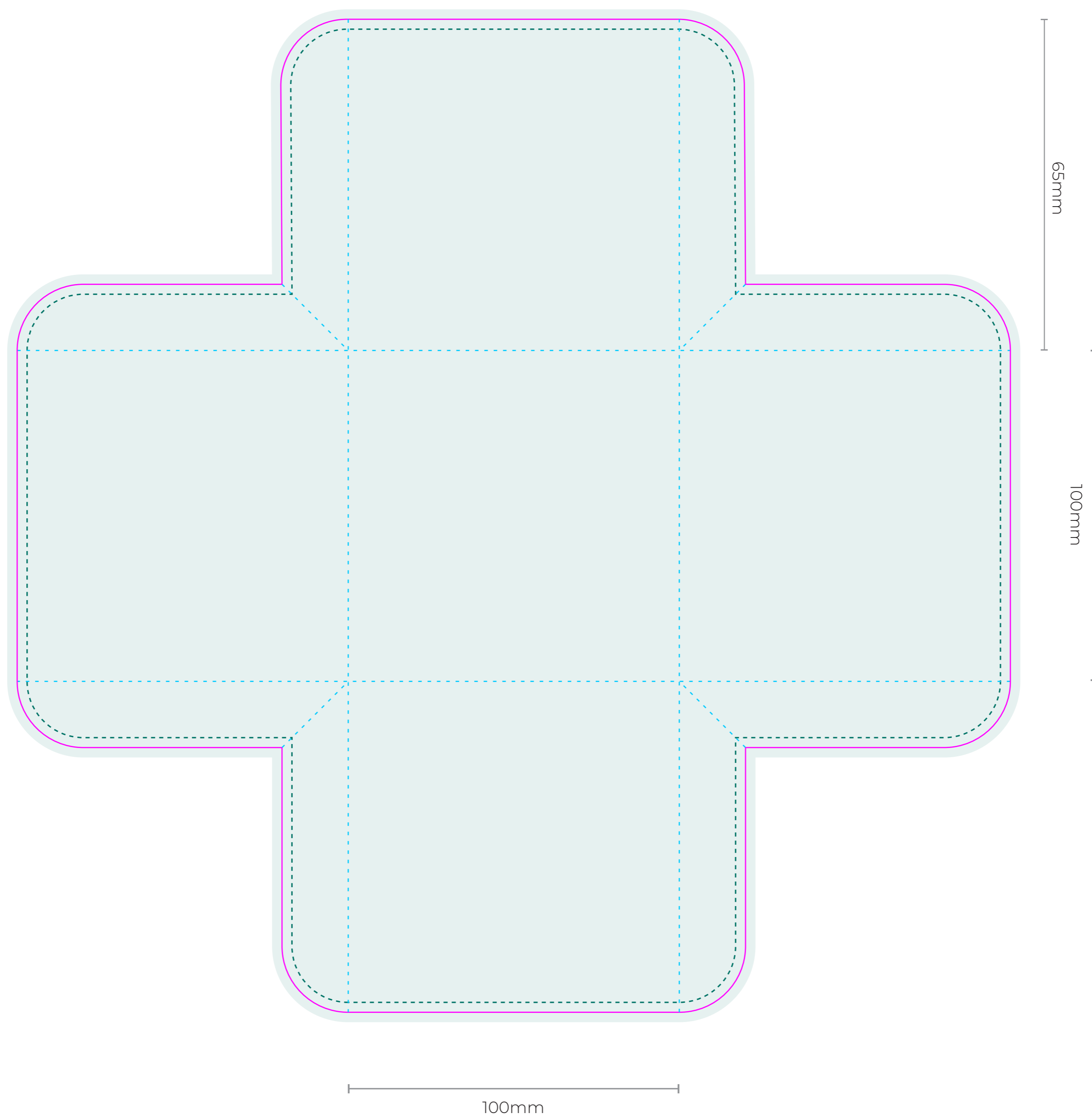

PAGE 1/4

OUTER ARTWORK

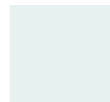

- PAPER ARTWORK SPECIFICATIONS**
- Create your artwork on the layer named "DESIGN"
 - Artwork to be in CMYK (Full Colour)
 - Allow 3mm bleed on artwork, add CROP MARKS
 - Keep text & graphics within the print safe area
 - Dieline set as Spot/PMS colour or on a separate layer
 - All Fonts outlined
 - Check images are 300dpi and embedded, NOT linked
 - File format must be hi-res PDF 10MB maximum file size

Artwork is best created in
Adobe Illustrator or Indesign

-  Dieline
-  Artwork Area
-  Print Safe Area
-  Fold/Score

Square Gift Box
Base - Finished size 100mm x 100mm x 65mm

PAGE 2/4

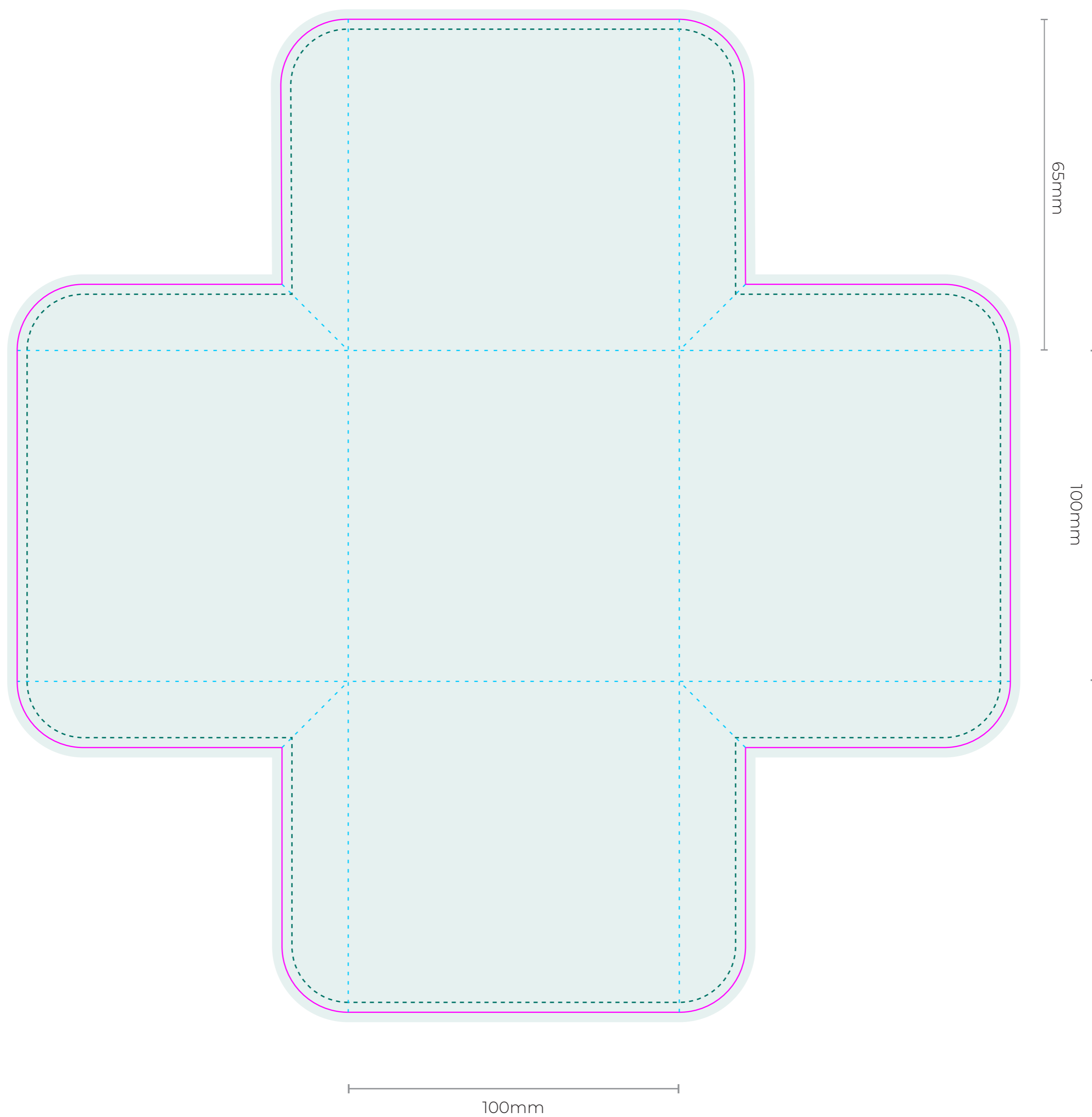

INSIDE ARTWORK



PAPER ARTWORK SPECIFICATIONS

- Create your artwork on the layer named "DESIGN"
- Artwork to be in CMYK (Full Colour)
- Allow 3mm bleed on artwork, add CROP MARKS
- Keep text & graphics within the print safe area
- Dieline set as Spot/PMS colour or on a separate layer
- All Fonts outlined
- Check images are 300dpi and embedded, NOT linked
- File format must be hi-res PDF 10MB maximum file size

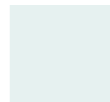
Artwork is best created in
Adobe Illustrator or Indesign

-  Dieline
-  Artwork Area
-  Print Safe Area
-  Fold/Score

Square Gift Box
 Lid - Finished size 102mm x 102mm x 80mm

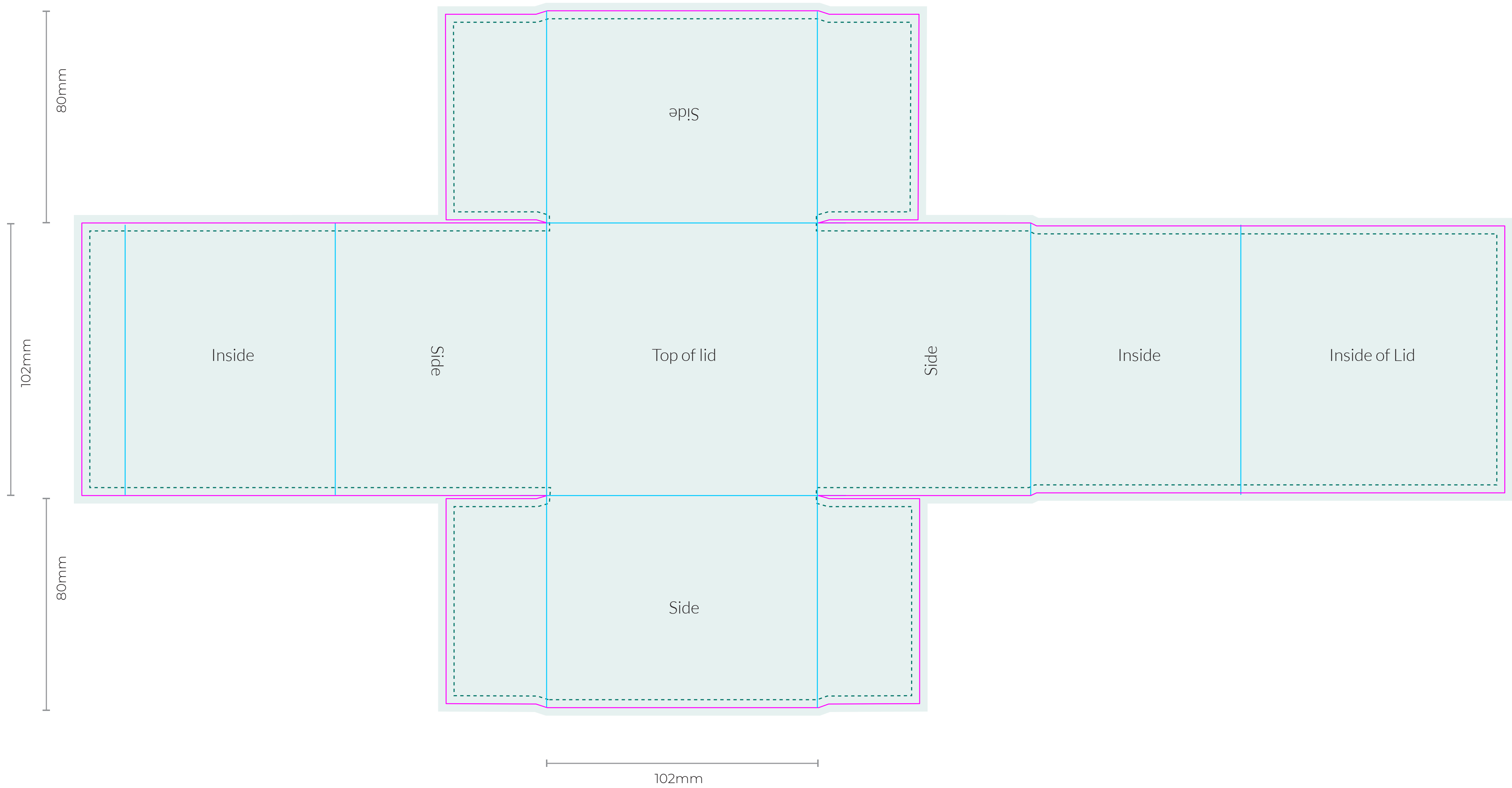

PAPER ARTWORK SPECIFICATIONS

- Create your artwork on the layer named "DESIGN"
- Artwork to be in CMYK (Full Colour)
- Allow 3mm bleed on artwork, add CROP MARKS
- Keep text & graphics within the print safe area
- Dieline set as Spot/PMS colour or on a separate layer
- All Fonts outlined
- Check images are 300dpi and embedded, NOT linked
- File format must be hi-res PDF 10MB maximum file size

Artwork is best created in
Adobe Illustrator or Indesign

- Dieline
- Artwork Area
- Print Safe Area
- Fold/Score

Christmas Complimentary Tag
77mm x 48.5mm
Single Sided

PAGE 4/4

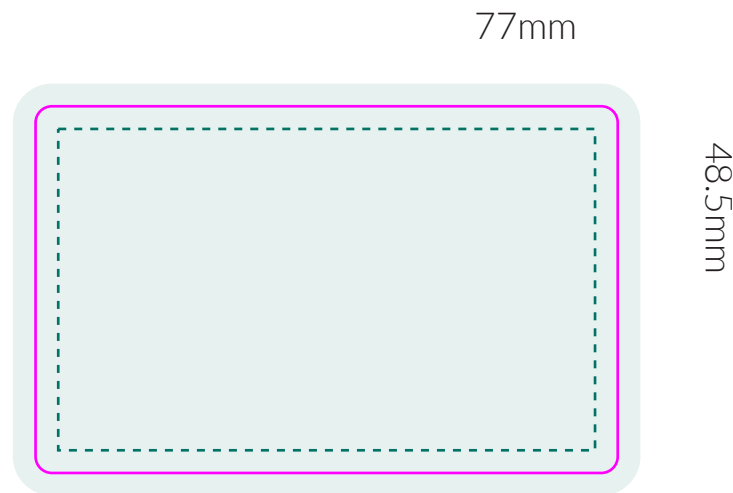

PLASTIC CARD ARTWORK SPECIFICATIONS

- Create your artwork on the layer named "DESIGN"
- Artwork to be in CMYK (Full Colour)
- Allow 3mm bleed on artwork, NO crop marks
- Keep text & graphics within the print safe area
- Dieline set as Spot/PMS colour or on a separate layer
- All Fonts outlined
- Check images are 300dpi and embedded, NOT linked
- File format must be hi-res PDF 10MB maximum file size

Artwork is best created in
Adobe Illustrator or Indesign



Dieline



Artwork Area



Print Safe Area